

ETHRATECH

INNOVATION AS ENERGY



AN ENEX TECHNOLOGIES COMPANY



PRODUCTS

OVERVIEW

HISTORY

Ethra Tech was born in 1999 in telecommunications sector, that has grown and developed rapidly for more than 20 years, so that all the Network Operators have sought partners capable of offering technologically advanced and reliable solutions, able to resolve any technical difficulty in the implementation of their own Networks.

The company has developed with the market and from the beginning it was able to guarantee quality, reliability, the search for new solutions and service to the customer.

Its Main Office is located in Umbria in Massa Martana, and thanks to partnerships with selected companies of the sector Ethra Tech has succeeded in covering the entire country with direct or indirect personnel. This territorial coverage enables us to guarantee on-site technical service within few hours.

As regards the Future of the company, there will be a consolidation of its own position in the markets which see it as one of the main air conditioner suppliers, as well as a development towards Foreign Markets creating new collaboration with foreign local companies with the aim of providing high quality products and services.

In the productive area Ethra Tech supplies refrigeration systems for:

- Telecommunications
- Data Center
- Railway
- Motorway
- Industrial environments
- Automotive refrigeration



RATECH
SOLUTION AS ENERGY
ENEX TECHNOLOGIES COMPANY



A background image showing several hands in business attire stacking wooden blocks on a wooden surface. The blocks are arranged in several vertical columns of varying heights, symbolizing construction, teamwork, and building a business. The lighting is soft and natural, suggesting an outdoor or well-lit indoor setting.

MISSION

PLANNING, PRODUCING, INSTALLING and PROVIDING SERVICING to the customer during all the work phases represents ETHRATECH's business MISSION.

Ethra Tech is able to develop CUSTOMIZED SOLUTIONS even for requests for a limited number of units, in order to meet increasingly specific requirements. Business FLEXIBILITY enables us to "CUSTOMIZE" the product according to the installation needs of the customer. The added value of the solutions proposed lies in a research and development team capable of interacting with the customer during each planning phase.

In this respect Ethra Tech offers itself as a top level partner from an economic, productive and organizational point of view.

Thanks to partnership with numerous leading companies in the electronics and air conditioning sectors, ETHRATECH has at its disposal innovative systems for the supply of its products that allow the customer always to keep up with the increasingly demanding requirements of the market.

Ethra Tech considers research activity to be fundamental. Such activity is developed both in collaboration with research laboratories (Private, public or University Bodies) and within the company where the planning, engineering and testing of the products is carried out.

In recent years particular attention has been dedicated to the search for solutions for Energy Saving and Noise reduction. Ethra Tech has developed ventilation systems, supply and extract, that can operate either independently or in combination with any air conditioner. The combined system reduces energy consumption considerably. The entire system is completely managed by electronics developed by the company, hardware and software is 'customised' to the customer's requirements.

To complete the MISSION we have the TECHNICAL TRAINING of the customer. The results obtained by our research are then passed on to our customers technical courses through organized by Ethra Tech .

Ethra Tech regularly organizes for our partners, at the Massa Martana branch, technical courses regarding the equipment, their installation and maintenance.



QUALITY AND ENVIRONMENT

Achieving excellence is the main aim of the business Functions: from research and development to planning, from production to distribution and technical assistance.

The ISO9001, ISO14001 and ISO45001 certification, is the result of the company's desire to satisfy globally any request from any customer.

In the area of production each stage is controlled methodically and constantly by expert and qualified personnel, from the raw materials to the final tests. All the products are analysed one by one before being released for the customer.

Thanks to all of this Ethra Tech is able to guarantee high qualitative standards in all phases of project realization.

Ethra Tech operates according to an integrated Quality, Environment, Safety System developing products with the least environmental impact that respect people and the environment, making each day better than the one before.

All Ethra Tech products are guaranteed MADE IN ITALY, and comply with all the regulations in force on the international market.

In recent years the design of new machines has dedicated particular attention to air conditioners that operate:

- Using ecological refrigerant gases such as R454C, R513A and R1234yf
- Saving energy
- Avoiding noise pollution (maximum noise reduction)

REFERENCES

Ethra Tech has a consolidated experience with the main Telecommunications Operators in Italy and Abroad, obtaining the homologation of its own solutions by Customers like TELECOM ITALIA, WIND TRE, VODAFONE, RAIWAY, ADIF and others.

Tens of thousands of solutions with our air conditioners testify to Ethra Tech leadership in this sector.

Ethra Tech works both in Italy and abroad as a strategic partner of the main Technology Providers, like ERICSSON NETWORKS, NOKIA SOLUTION, HUAWEI, ZTE.

Moreover, it produces appliances of low refrigerant power, for the refrigeration of cabinets and power panels.

Many companies, that work in the industrial sector, in particular siderurgy, have chosen to install our line of products inside foundries or other exacting environments in which very high temperatures and the problem of dust particles are found.

Thanks to collaboration with the MILITARY sector, Ethra Tech has supplied air conditioners for military applications, for the cooling of shelters and technological rooms.

The company is able to provide pre- and post-sale services also abroad, through qualified partners.



TECHNOLOGIES

INVERTER

Air conditioners with Inverter technology make it possible to obtain considerable energy saving with advantages also in terms of thermal and acoustic comfort; specifically, the regulation of temperature is obtained by means of variation of the rotation speed of the compressor

ASC AND MP16 CONTROLLER

ASC and MP16 controllers installed on the air conditioners to manage all their functions and control simultaneously free-cooler and free-cooling systems, ensuring control of the whole air-conditioning process in technological premises and the like where, in addition to guaranteeing all of the above, they ensure high levels of reliability.

The large number of inlets and outlets make our controllers as flexible as a PLC.

FREE-COOLER SYSTEM

A solution that was designed to make possible ENERGY SAVING even on those sites where air-conditioners without free-cooling system have been previously installed.

The unit includes: an air intake system (free-cooler ventilator) and an air extraction system (over pressure shut-off dampers).

TELECOMMUNICATIONS

OUTDOOR PACKAGED UNIT — ED SERIE



Cooling capacity 6,3 ÷ 14kW
 Operation limits -20°C ÷ +45°C
 On-off / inverter
 Electronic temperature control



Outdoor packaged air conditioning units air cooled type, ideals for installations inside room, shelter for radio base station and data processing centre.

The flexibility of these systems allows to the customer to configure the air conditioner according to his needs (free-cooling, heating, remote PLC, etc).

Cooling mode

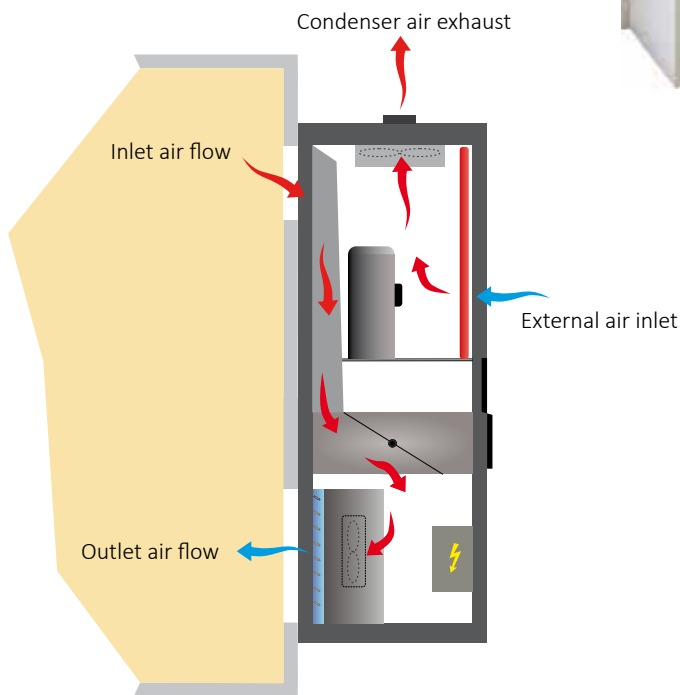

Main Features

- Mainframe and panels made of galvanized steel
- High corrosion resistant
- Aluminum-aluminum microchannel condenser battery
- Automatic restart after absence power supply

Free Cooling mode

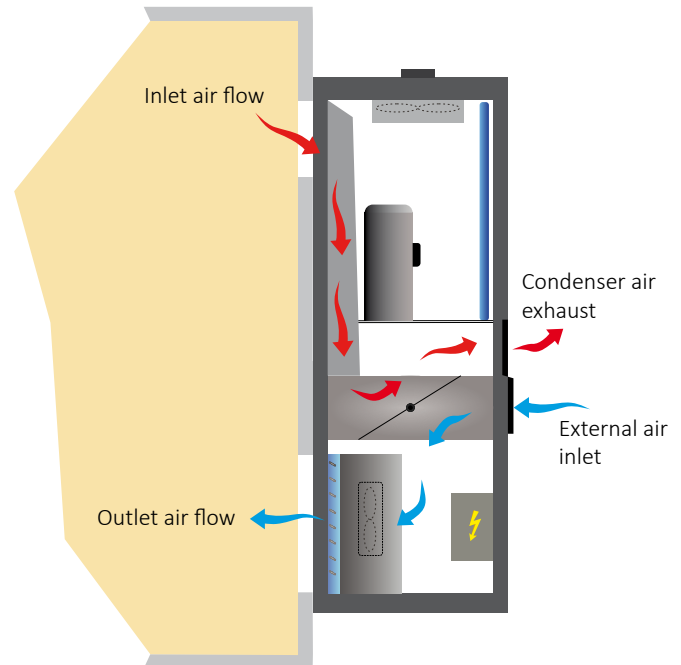

Model		AE50ER1DP	AE80ER1DP	AE80ER3DP	AE100ER3DP	AE140ER3DP
Compressor		Hermetic	Hermetic	Hermetic	Hermetic	Hermetic
Total cooling capacity ⁽¹⁾	W	6300	8100	8100	10200	14100
Sensitive cooling capacity	W	6300	8100	8100	10200	14100
Heating capacity (optional)	W	1500	3000	3000	3000	3000
Voltage supply	V/pH/Hz	230/1/50	230/1/50	400/3+N/50	400/3+N/50	400/3+N/50

(1) External Temperature 35°C- Inside Temperature 30°C- R.H. =20%

INDOOR PACKAGED UNIT – ID SERIE



Cooling capacity 6,1 ÷ 13,9kW
 Operation limits -20°C ÷ +45°C
 On-off / inverter
 Electronic temperature control

- EC evaporation section fans
- The fans of the condensation section have a variable speed in accordance with the condensation pressure
- Electronic thermostatic valve
- 48Vdc air treatment section



Cooling mode

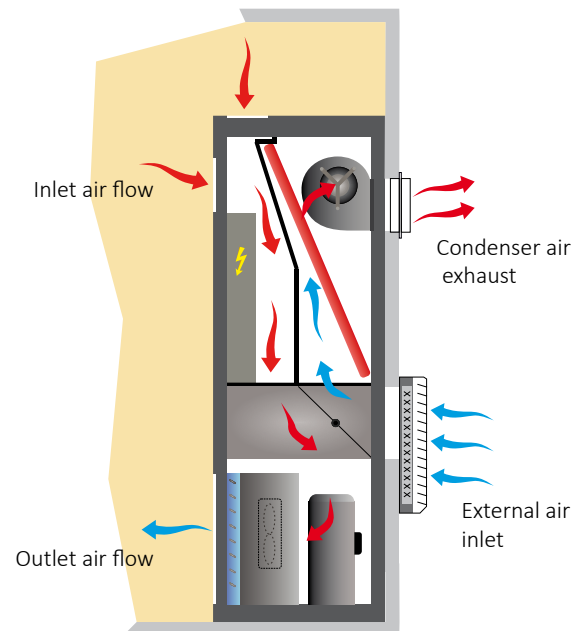

Free Cooling mode

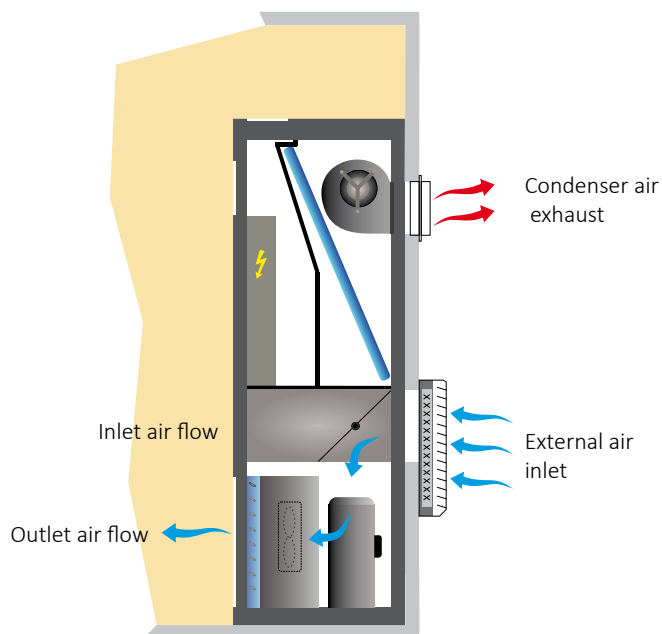

Cooling mode (IS)

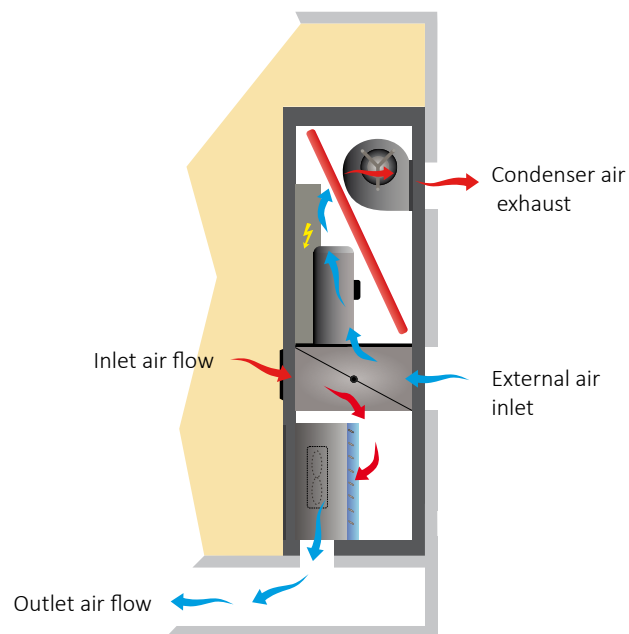

Model		AE50IR1DP	AE80IR1DP	AE80IR3DP	AE100IR3DP	AE140IR3DP
Compressor		Hermetic	Hermetic	Hermetic	Hermetic	Hermetic
Total cooling capacity ⁽¹⁾	W	6100	7900	7900	10000	13900
Sensitive cooling capacity	W	6100	7900	7900	10000	13900
Heating capacity (optional)	W	1500	3000	3000	3000	3000
Voltage supply	V/pH/Hz	230/1/50	230/1/50	400/3+N/50	400/3+N/50	400/3+N/50

(1) External Temperature 35°C- Inside Temperature 30°C- R.H. =20%

TELECOMMUNICATIONS

PACKAGED AIR CONDITIONING UNITS RR SERIE



Cooling capacity 1,7 ÷ 4,3kW
 Operation limits -20°C ÷ +45°C
 On-off / inverter
 Electronic temperature control



RR Series packaged air conditioning units air cooled type, suitable for installations in room, shelter for radio base station and data processing centre.

RR air conditioning units can be supplied in two different versions:

- INDOOR installation
- OUTDOOR installation

Main Features

- Mainframe and panels made of galvanized steel
- High corrosion resistant
- Electrical board with external interface user panel
- Automatic restart after absence power supply

External cooling mode

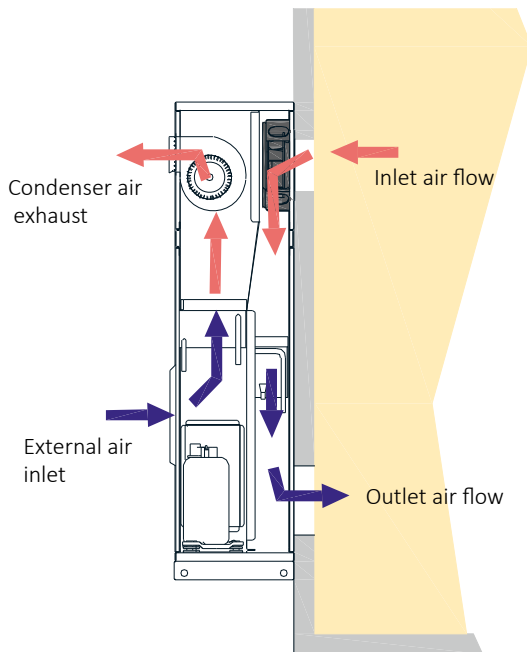

Internal cooling mode

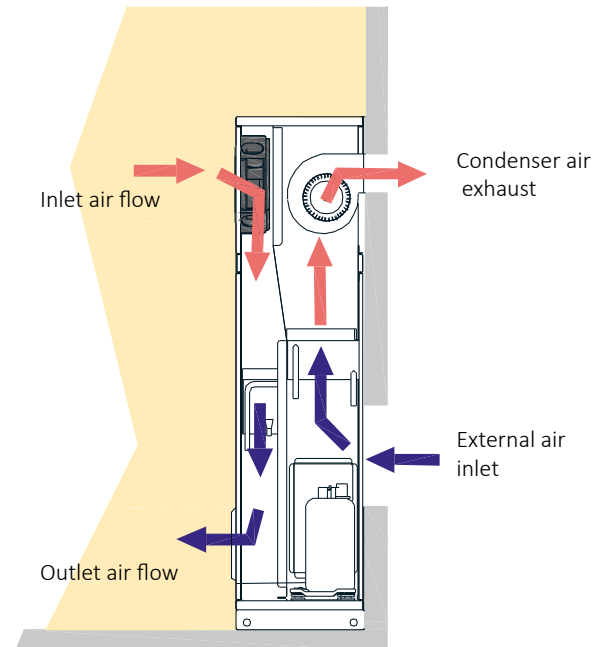

Model		AE15RR1	AE25RR1	AE35RR1	AE45RR1
Compressor		Hermetic	Hermetic	Hermetic	Hermetic
Total cooling capacity ⁽¹⁾	W	1700	2300	3500	4300
Sensitive cooling capacity	W	1700	2300	3500	4300
Heating capacity (optional)	W	1500	1500	1500	1500
Voltage supply	V/pH/Hz	230/1/50	230/1/50	230/1/50	230/1/50

(1) External Temperature 35°C- Inside Temperature 30°C- R.H. =20%

PACKAGED AIR CONDITIONING UNITS RF SERIE



Cooling capacity 5 ÷ 14kW
 Operation limits -20°C ÷ +45°C
 On-off / inverter
 Electronic temperature control

- The fans of the condensation section have a variable speed in accordance with the condensation pressure
- 48Vdc air treatment section
- Eu3 class air filter



External cooling mode

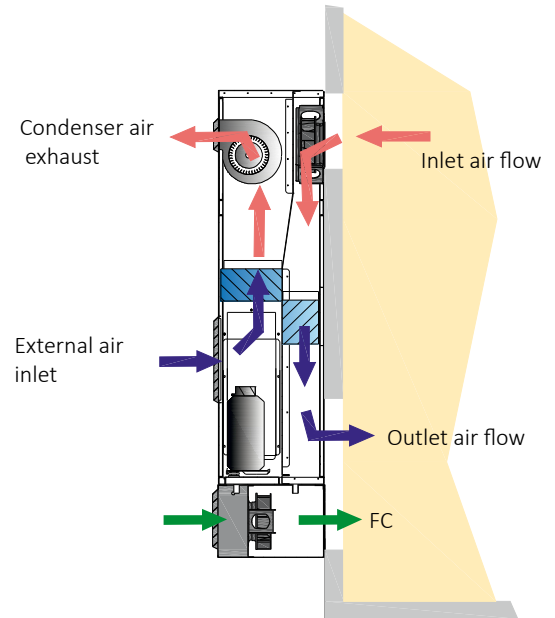

Internal cooling mode

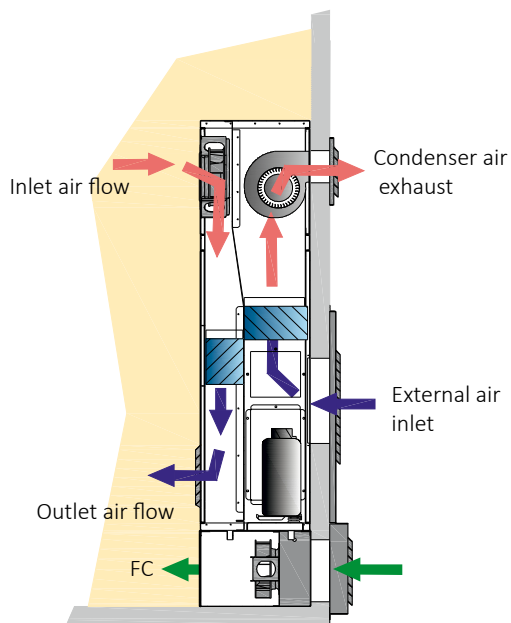

Griglie esterne / interne

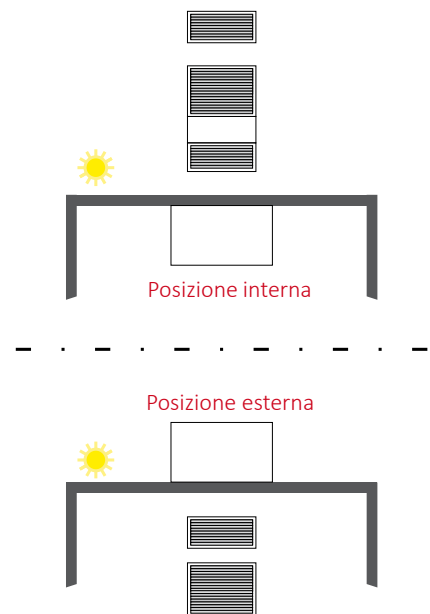

Model		AE15RF1	AE25RF1	AE35RF1	AE45RF1
Compressor		Hermetic	Hermetic	Hermetic	Hermetic
Total cooling capacity ⁽¹⁾	W	1700	2300	3500	4300
Sensitive cooling capacity	W	1700	2300	3500	4300
Heating capacity (optional)	W	1500	1500	1500	1500
Voltage supply	V/pH/Hz	230/1/50	230/1/50	230/1/50	230/1/50

(1) External Temperature 35°C- Inside Temperature 30°C- R.H. =20%

TELECOMMUNICATIONS

SPLIT SYSTEM – CEILING SERIES



Cooling capacity 6,3 ÷ 14,2kW
 Operation limits -20°C ÷ +45°C
 On-off / inverter
 Electronic temperature control

Split air conditioning units air cooled type, suitable for installations inside room, shelter for radio base station and data processing centre. The air flow of the internal unit can be delivered vertically (displacement) or horizontally (conventional).

Other versions

Vertical
 T Series (Three units)



Indoor unit



Outdoor unit

Main Features

- External unit with painted steel made mainframe
- Internal unit with aluminum made mainframe and panels
- High corrosion resistant
- Aluminum-aluminum microchannel condenser battery

Cooling mode

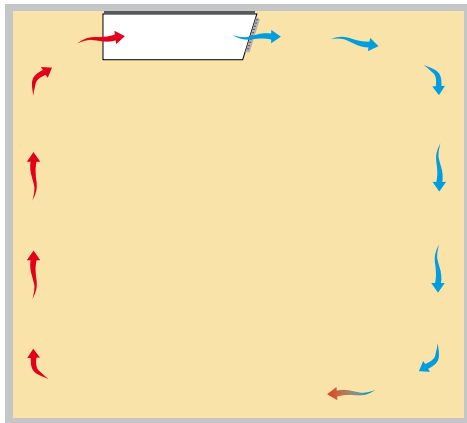

Free Cooling mode

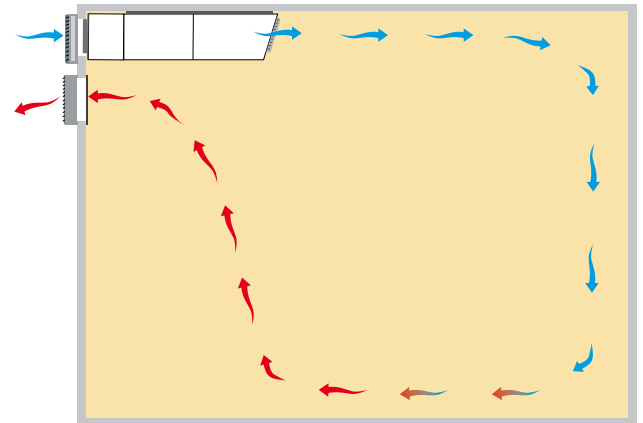

Model		AE50SF1DP	AE80SF1DP	AE80SF3DP	AE100SF3DP	AE140SF3DP
Compressor		Hermetic	Hermetic	Hermetic	Hermetic	Hermetic
Total cooling capacity ⁽¹⁾	W	6300	8600	8600	10200	14200
Sensitive cooling capacity	W	6300	8600	8600	10200	14200
Heating capacity (optional)	W	1500	3000	3000	3000	3000
Voltage supply	V/pH/Hz	230/1/50	230/1/50	400/3+N/50	400/3+N/50	400/3+N/50

(1) External Temperature 35°C- Inside Temperature 30°C- R.H. =20%

SPLIT SYSTEM – UP SERIES



Cooling capacity 2,0 ÷ 17,2kW
 Operation limits -20°C ÷ +45°C
 On-off / inverter
 Electronic temperature control

The conditioners Under series are air cooled split system, ideal for installations inside room, shelter for radio base station and data processing centre. The adjustment of the temperature is got by means of the cooling capacity variation of the air conditioner through Inverter technology (rotation speed variation of compressor).

- Automatic restart after absence power supply
- Fans evaporating section type EC
- The fans of the condensation section have a variable speed in accordance with the condensation pressure
- Electronic thermostatic valve
- 48Vdc air treatment section



Indoor unit



Outdoor unit

Free Cooling mode

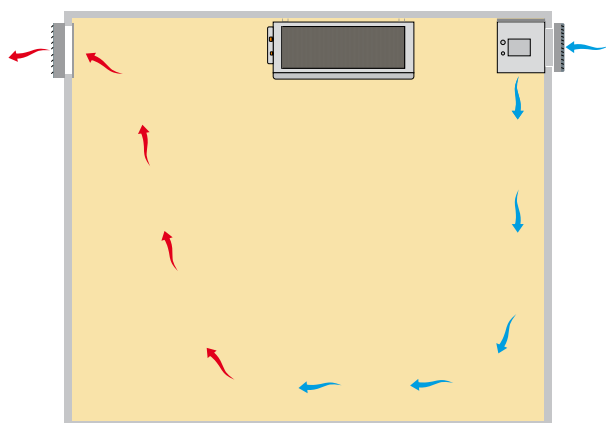

Cooling mode

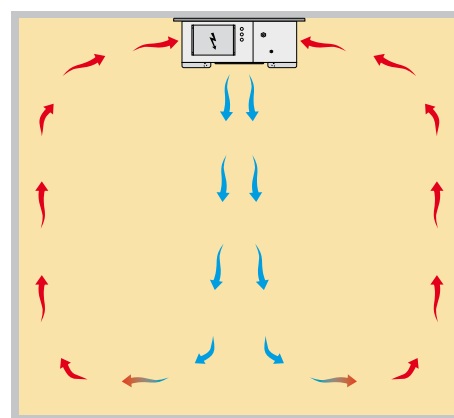

Model		AE2/8SR1UP AE2/8SR3UP	AE3/10SR3UP	AE5/14SR3UP	AE6/17SR3UP
Compressor		Inverter Hermetic	Inverter Hermetic	Inverter Hermetic	Inverter Hermetic
Total cooling capacity ⁽¹⁾	W	2000 / 8400	3000 / 10400	5000 / 14200	6000 / 17200
Sensitive cooling capacity	W	2000 / 8400	3000 / 10400	5000 / 14200	6000 / 17200
Heating capacity (optional)	W	1500	3000	3000	3000
Voltage supply	V/pH/Hz	230/1/50 400/3+N/50	400/3+N/50	400/3+N/50	400/3+N/50

(1) External Temperature 35°C- Inside Temperature 30°C- R.H. =20%

INDUSTRIAL ENVIRONMENT

OUTDOOR PACKAGED UNITS — ACU SERIES

R134a



Cooling capacity 4,2 ÷ 5,8 kW
 Operation limits -40°C ÷ +80°C
 Electronic temperature control



Operating mode

Packaged air conditioning units, specifically designed and manufactured to operate in extreme conditions in presence of dust and vibration and high temperature.

Main Features

- Mainframe and panels made of galvanized steel
- High corrosion resistant
- Electrical board with external interface user panel
- Automatic restart after absence power supply
- The fans of the condensation section have a variable speed in accordance with the con-

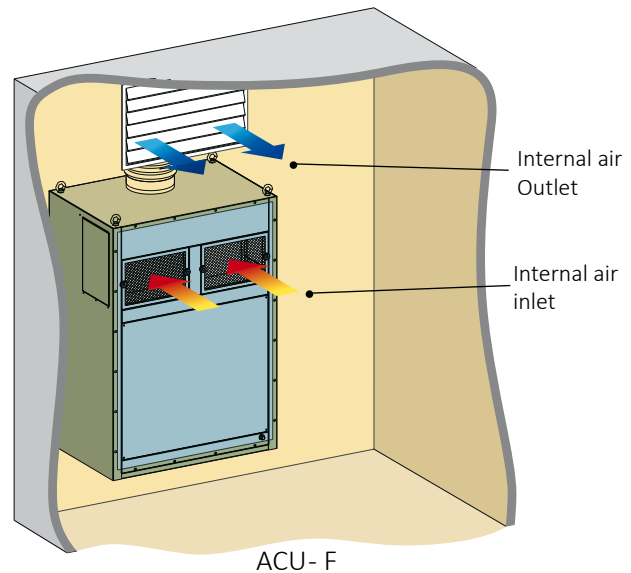
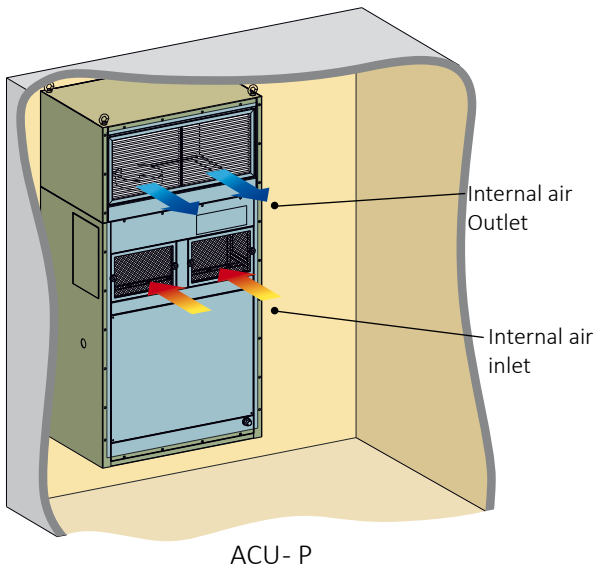

Model		ACU401	ACU601
Compressor		Hermetic	Hermetic
Total cooling capacity ⁽¹⁾	W	4200	5850
Sensitive cooling capacity ⁽¹⁾	W	3950	5500
Voltage supply	V/pH/Hz	400/3/50	400/3/50

(1) External Temperature 60°C- Inside Temperature 30°C- R.H. =50%

OUTDOOR PACKAGED UNITS — ACU-Q SERIES

R134a



Cooling capacity 4,2 ÷ 9,5 kW
 Operation limits -40°C ÷ +80°C
 Electronic temperature control

condensation pressure

- Metallic air filter
- Working at external temperatures from -40°C up to 80°C
- Resistance to dust and vibrations



Operating mode

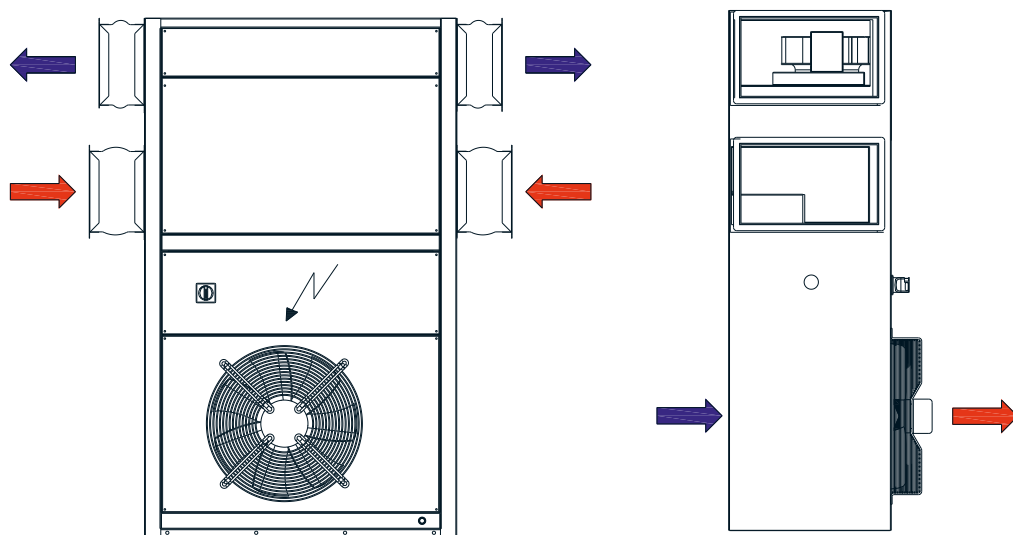

Model		ACU401	ACU601	ACU901
Compressor		Hermetic	Hermetic	Hermetic
Total cooling capacity ⁽¹⁾	W	4200	5850	9500
Sensitive cooling capacity ⁽¹⁾	W	3950	5500	8900
Voltage supply	V/pH/Hz	400/3/50	400/3/50	400/3/50

(1) External Temperature 60°C- Inside Temperature 30°C- R.H. =50%

INDUSTRIAL ENVIRONMENT

INDOOR PACKAGED UNITS — CUS SERIES

R134a



Cooling capacity 2,7 ÷ 4,5 kW
 Operation limits -40°C ÷ +80°C
 Electronic temperature control



Packaged air conditioning units, specifically designed and manufactured to operate in extreme conditions in presence of dust and vibration and high temperature.

Operating mode

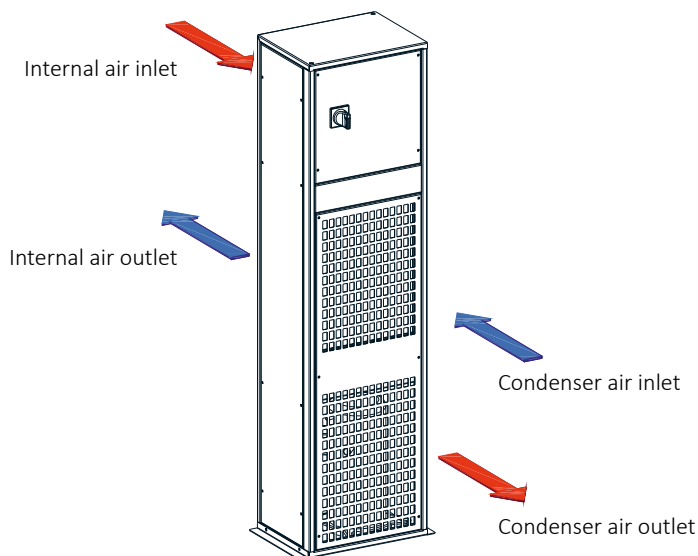

Main Features

- Mainframe and panels made of galvanized steel
- High corrosion resistant
- Electrical board with external interface user panel
- Automatic restart after absence power supply
- The fans of the condensation section have a variable speed in accordance with the condensation pressure
- Metallic air filter
- Working at external temperatures from -40°C up to 80°C
- Resistance to dust and vibrations

Model		CUS183	CUS222	CUS301
Compressor		Scroll	Scroll	Scroll
Total cooling capacity ⁽¹⁾	W	1800	2500	2800
Sensitive cooling capacity ⁽¹⁾	W	1700	2350	2600
Voltage supply	V/pH/Hz	230/1/50	460/3/60	400/3/50

(1) External Temperature 60°C- Inside Temperature 30°C- R.H. =50%

SPLIT AIR CONDITIONING UNITS – AI SERIES

R134a



Cooling capacity 6,2 ÷ 8,7 kW
 Operation limits -20°C ÷ +75°C
 Electronic temperature control



Main Features

- Mainframe and panels made of galvanized steel
- High corrosion resistant
- Electrical board with external interface user panel
- Automatic restart after absence power supply
- HP fan is regulated by pressure switch
- Working at external temperatures from -20°C up to 75°C
- Resistance to dust and vibrations

Operating mode (ceiling unit)

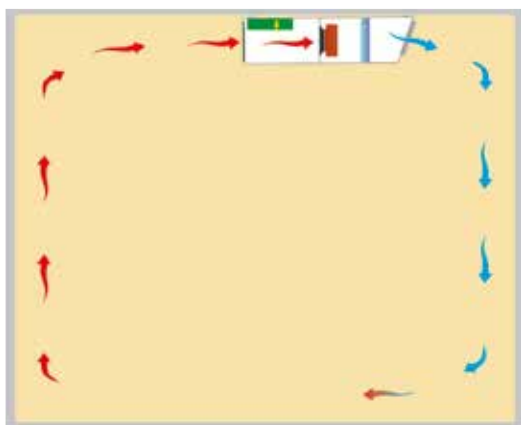

Operating mode (vertical unit)

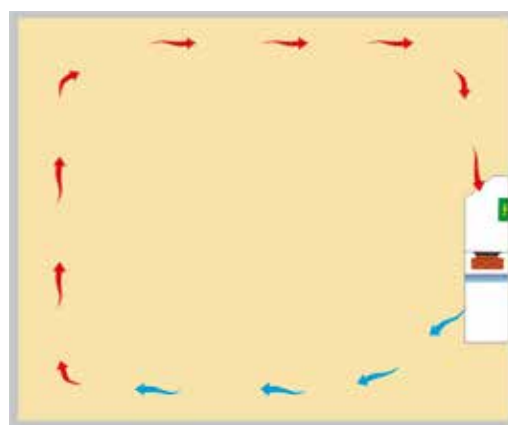

Model	AI60SR3DC			AI60SR3DCV			AI80SR3DC		AI80SR3DCV		
	(1)	(2)	(3)	(1)	(2)	(3)	(1)	(3)	(1)	(3)	
Indoor unit		Ceiling			Vertical			Ceiling		Vertical	
Compressor					Semihhermetic						
Total cooling capacity ⁽¹⁾	W	6200	5500	4700	6200	5500	4700	8700	5600	8700	5600
Sensitive cooling capacity ⁽¹⁾	W	6000	5300	4700	6000	5300	4700	8300	5400	8300	5400
Voltage supply		V/pH/Hz			400/3/50 +N +T						

(1) External Temperature 35°C- Inside Temperature 27°C- R.H. =50%

(2) External Temperature 60°C- Inside Temperature 30°C- R.H. =50%

(3) External Temperature 70°C- Inside Temperature 30°C- R.H. =50%

ELECTRICAL BOARDS

INDOOR AIR CONDITIONING UNITS - CU ALX SERIES



Cooling capacity 0,6 ÷ 2,5 kW
 Operation limits -40°C ÷ +80°C
 Electronic temperature control



CU_ALX series are internal packaged-type, ideal for cooling of electrical boards and similar items for indoor applications. They are designed to be positioned outside the electrical boards (wall-mount).

Operating mode

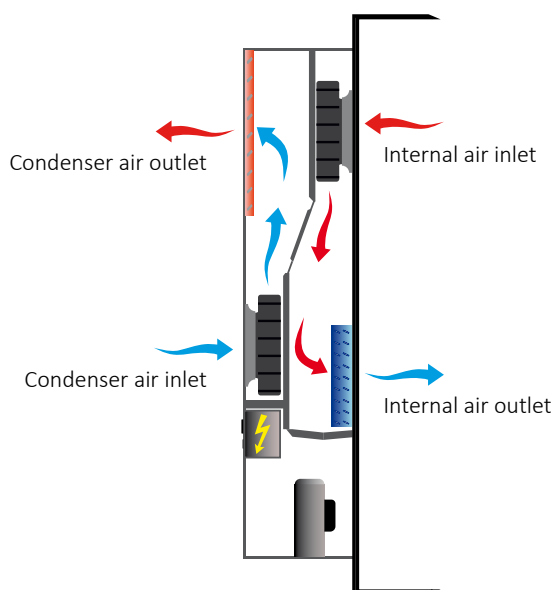

Caratteristiche principali

- High efficiency
- Mainframe and panels made of galvanized steel
- Aluminum-aluminum microchannel condenser battery
- Automatic restart after power supply absence
- Alarm contact (only with electronic regulator)
- 230Vac radial fans
- Hermetic alternative compressor
- Automatic condensate evaporation (mod.250 excluded)
- Functioning up to +55°C external temperature

Model		CU060AL		CU100AL		CU150AL		CU200AL		CU250AL	
Voltage supply	V/pH	230/1		230/1		230/1		230/1		230/1	
Frequency	Hz	50	60	50	60	50	60	50	60	50	60
Cooling capacity ⁽¹⁾	W	560	600	1090	1145	1510	1590	1950	2050	2400	2500
Absorbed power	W	270	315	475	540	775	870	810	885	1040	1140

(1) External Temperature 35°C- Inside Temperatura 35°C- R.H. =20%

INDOOR AIR CONDITIONING UNITS - CU ORZ SERIES

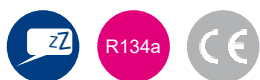

Cooling capacity 0,3 kW
 Operation limit -40°C ÷ +80°C
 Electronic temperature control



Operation mode

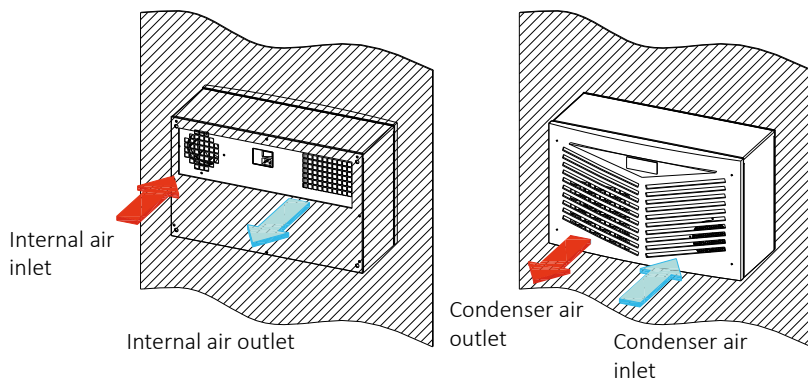

Model	CU030RZ
Voltage supply	230
Frequency	50
Cooling capacity ⁽¹⁾	300
Absorbed power	180

(1) External Temperature 35°C- Inside Temperature 30°C- R.H. =50%

AIR CONDITIONING UNITS - CU ROOF SERIES



Cooling capacity 0,9 ÷ 1,4 kW
 Operation limit -20°C ÷ +55°C



Operation mode

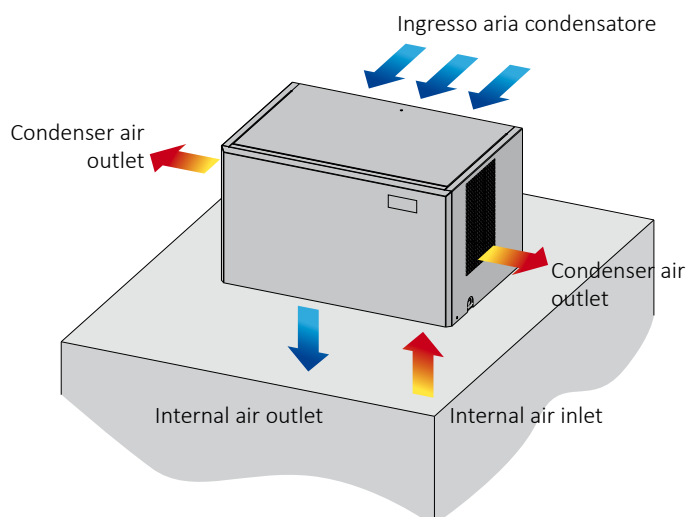

Model		CU085ROOF		CU100ROOF		CU140ROOF	
Voltage supply	V/pH	230/1		230/1		230/1	
Frequency	Hz	50	60	50	60	50	60
Cooling capacity ⁽¹⁾	W	860	940	1000	1100	1400	1600
Absorbed power	W	420	470	480	560	680	750

(1) External Temperature 35°C- Inside Temperature 30°C- R.H. =50%

FREE COOLING SYSTEMS

INTERNAL FREE-COOLER KIT - PASCI SERIES



Indoor installation

Air flow rate 1500 m³/h- 3000 m³/h



Operation mode

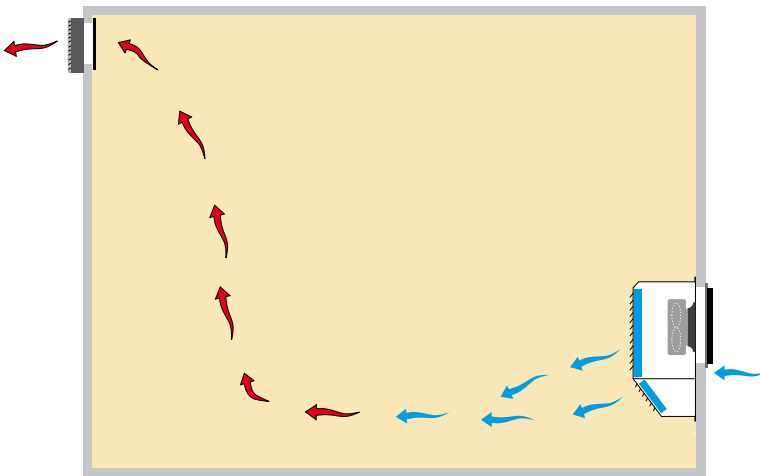

The Free-cooler system has the characteristic of guaranteeing continuous air changes with the primary objective of transferring the heat generated by the equipment to the external environment (for dissipation). Solution designed to allow high ENERGY SAVING also in site where air conditioning units without free cooling system were previously installed.

Main features

- External panels painted with epoxide powders
- Very light weight
- Easy operations for installation
- Easy access for service and maintenance
- Low noise levels

EXTERNAL FREE-COOLER KIT - PASCE SERIES



Outdoor installation

Air flow rate 1500 m³/h- 3000 m³/h

Operation mode

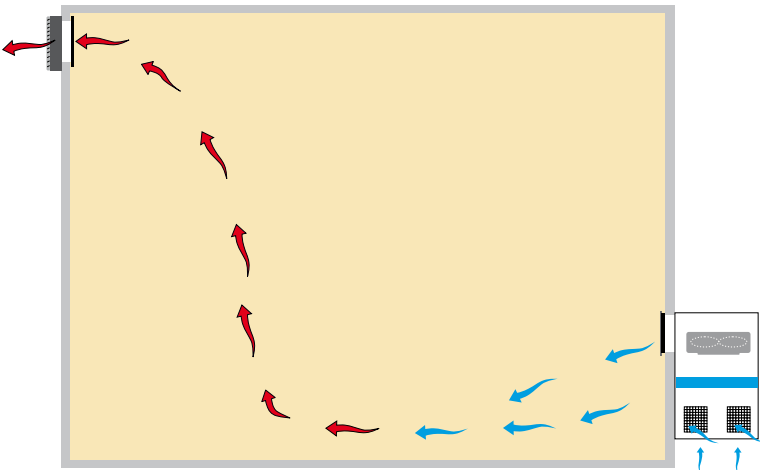

INTERNAL SETTLING CAMBER FREE-COOLER CAM-I-IM SERIES



The system of air INTRODUCTION with “Settling Chamber” has the characteristic of guaranteeing continuous air changes with the primary objective of transferring the heat generated by the equipment to the external environment (for dissipation). The Settling Chamber can be installed externally or internally, in according with the typology of the installed air conditioners and with the space available inside the local.

Indoor installation

Air flow rate 2600 m³/h- 5000 m³/h



Operation mode

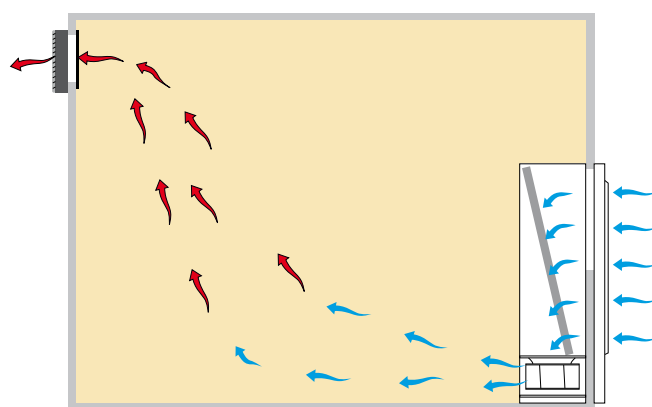

EXTERNAL SETTLING CAMBER FREE-COOLER CAM-E-IM SERIES



Outdoor installation

Air flow rate 2600 m³/h- 5000 m³/h



Operation mode

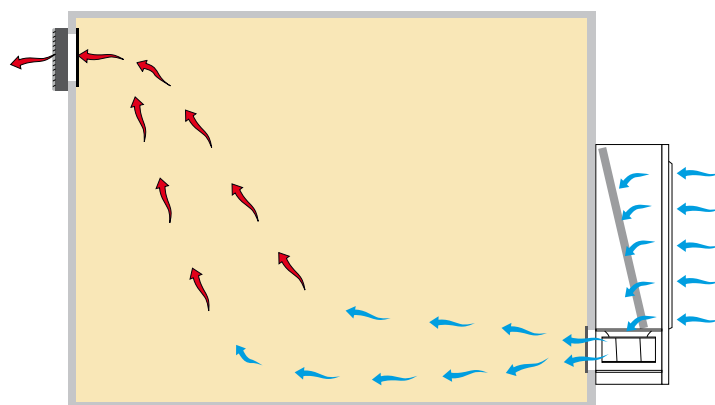

FREE COOLING SYSTEMS

EXTRACTION AIR SYSTEM WITH GRIDS - FCGR SERIES



Outdoor installation

Air flow rate 1000 m³/h- 4000 m³/h



The Free-cooler system has the characteristic of guaranteeing continuous air changes with the primary objective of transferring the heat generated by the equipment to the external environment (for dissipation). Solution designed to allow high ENERGY SAVING also in site where air conditioning units without free cooling system were previously installed.

Operation mode

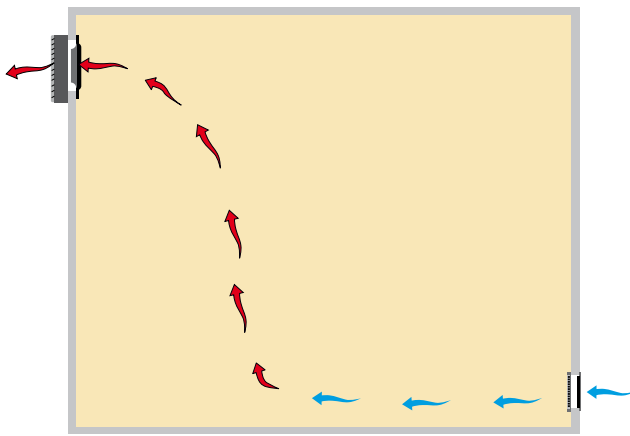

Main features

- Very light weight
- Easy operations for installation
- Easy access for service and maintenance
- Low noise levels

CANALIZED FREE-COOLER KIT VFC SERIES



Outdoor installation

Air flow rate 1000 m³/h- 4000 m³/h

The VFC SERIES air extraction system is composed by one or more centrifugal fans extracting the exhaust air from the internal environment and by a PLC controlling the entire working cycle and managing and generating the related alarm conditions.



Operation mode

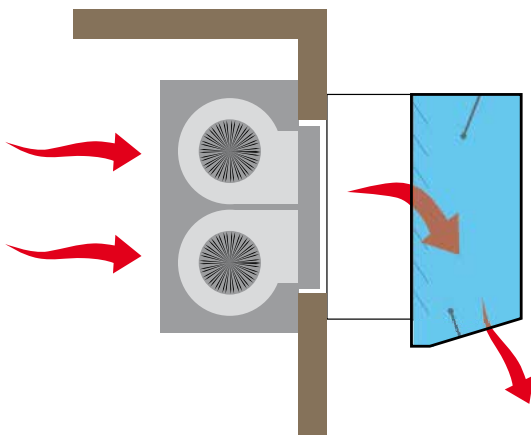

Canalized installation example (on request)

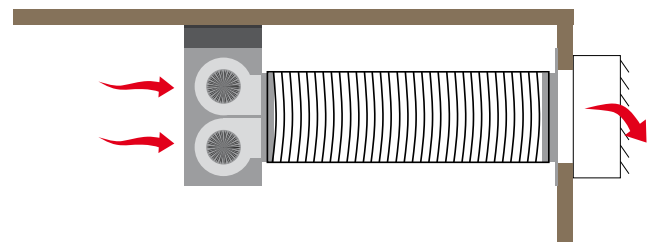

SETTLING CHAMBER FREE-COOLER CAM-I-ES SERIES



The system of air EXTRACTION with "Settling Chamber" has the characteristic of guaranteeing continuous air changes with the primary objective of transferring the heat generated by the equipment to the external environment (for dissipation). The settling chamber can be installed externally or internally, in according with the typology of the installed air conditioners and with the space available inside the local.

Indoor installation

Air flow rate 2000 m³/h- 4000 m³/h



Operation mode

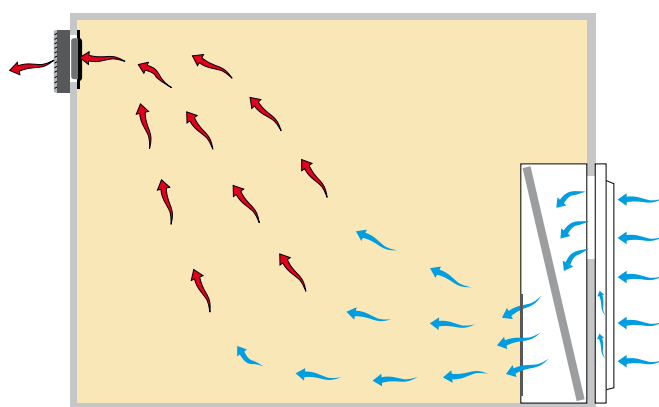

SETTLING CHAMBER FREE-COOLER CAM-E-ES SERIES



Outdoor installation

Air flow rate 2000 m³/h- 4000 m³/h



Modalità di funzionamento

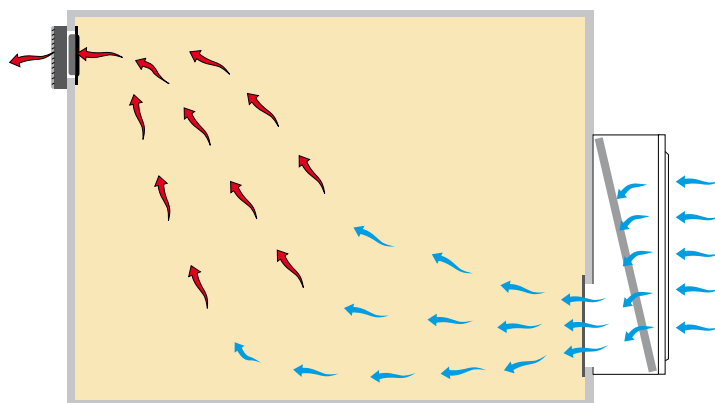



ETHRATECH

INNOVATION AS ENERGY



AN ENEX TECHNOLOGIES COMPANY

Emicon AC Spa
divisione **ETHRA TECH s.r.l.**
Via dell'Artigianato, 12 - 06056
Massa Martana (PG) Italy

www.ethratech.it
info@ethratech.it